

Project: \_\_\_\_\_

Type: \_\_\_\_\_

Drawn by: \_\_\_\_\_ Catalogue #: \_\_\_\_\_

Date: \_\_\_\_\_

## CR6 6" COMMERCIAL LED DOWNLIGHT

### Optional Emergency Remote

Our commercial 6 inch LED downlight is available for non-IC and remodeler construction. Up to 5 000 lm, the CR6 is perfect for all commercial lighting applications. The CR6 comes in a variety of lumen packages, color temperatures, finishes and beam angles to suit all needs.

### FEATURES AND SPECIFICATIONS

#### • Construction

##### Finishing

- Trims constructed with cold rolled steel
- A variety of trims styles and colors are available
- Lenses are available in clear or frosted and are constructed with glass material

##### Mounting

- 6 1/2" - 6 5/8" cutting hole
- Non-IC frame-in kit and remodeler installation options
- Housing constructed of heavy duty galvanized steel with built-in thermal protection

##### Optics

- High quality optic and reflector design
- Spot (15° to 21.5°)
- Narrow Flood (24° to 40.5°)
- Flood (38° to 44.2°)
- Wide (60° to 65°)

#### • Technical specification

- 19 W to 51 W, 120 V or 347 V
- 0-10V dimming standard
- LED chip binning 2-3 step MacAdam Ellipse to ensure color consistency
- Color temperature 2 700, 3 000, 3 500 and 4 000 K
- Estimated lifespan of 36 000 hours to L70
- Operating temperature: -40°C to 50°C (-40°F to 122°F)

#### • Optional Emergency Lighting

LINK Normally ON Emergency Remote Commercial LED Downlight

- Consuming 11 W, 12 -24 V DC
- 200 mA constant current
- Delivers 767 - 828 lumens in emergency mode
- Ease of maintenance when used with Stanpro emergency lighting battery units complete with auto test function
- Complements Stanpro's normally ON Commercial LED Downlight family
- Patent pending

*Please view the LINK specification section for more details on this technology*

#### • Emergency Lighting Compliances

- CSA certified as a C22.2 C141-15 emergency lighting luminaire
- Meets ICES-005 requirements

#### • General Lighting Compliances

- cCSAus rated for damp and wet location
- Meets requirements of ICES-005
- Air-tight as per ASTM-E283 standard



<sup>1</sup> 5 year warranty for the LINK module.

<sup>2</sup> Wet location when using frosted or clear lens.

### OVERVIEW

Light source	LED
Watts (W)	19 - 51
Lumen output (lm)	1 890 - 5 251
Efficacy (lm/W)	96 - 107
Color temperature (K)	2 700, 3 000, 3 500, 4 000
CRI	80+ , 90+
Weight (lbs)	4 - 6.12

**ORDERING GUIDE - TRIMS**

Series	Lumen package (lm)	CRI	Reflector finish	Baffle finish	Flange finish	Color temp. (K)	Beam angles <sup>1</sup> (°)	Options <sup>2</sup>
CR6	18 - 1 800 25 - 2 500 34 - 3 400 50 - 5 000	80 - 80+ 90 - 90+	C - Clear W - White	B - Black W - White 0 - No baffle	W - White B - Black	27 K - 2 700 30 K - 3 000 35 K - 3 500 40 K - 4 000	S - Spot (15) N - Narrow flood (24) F - Flood (38) W - Wide (60)	F - Frosted lens <sup>3</sup> L - Clear lens

<sup>1</sup> Refer to beam distribution chart for more details.

<sup>2</sup> When selecting lens options F (frosted lens) or L (Clear lens), you must select a Baffle finish of B (Black) or W (White). The "No Baffle" option does not apply when a lens option is selected.

<sup>3</sup> Lumen loss of 15%-18% to be expected.

**ORDERING GUIDE - HOUSINGS**

Series	Lumen package (lm) <sup>1</sup>	Voltage (V AC)	Option
CR6 - Non IC	18 - 1 800	A - 120	EL <sup>2</sup> - LINK Normally ON emergency remote
CR6R - Remodeler	25 - 2 500	H - 347	
	34 - 3 400		
	50 - 5 000		

<sup>1</sup> Please note that each housing and trim should correspond to a specific lumen package. For more information, please see Trims Ordering Guide above.

<sup>2</sup> When in emergency mode, luminaire only consumes 11 W.

For emergency lighting spacing, please see page 4.

**TECHNICAL SPECIFICATION TABLE**

Lumen package	Watts (W)	Volts (V AC)	2 700 K		3 000 K		3 500 K		4 000 K		CRI	Life L70 (hrs)	Beam angle (°)	Power factor	THD (%)
			Lumen (lm)	Efficacy (lm/W)	Lumen (lm)	Efficacy (lm/W)	Lumen (lm)	Efficacy (lm/W)	Lumen (lm)	Efficacy (lm/W)					
18	19	120	1 890	99	1 964	103	2 027	107	2 039	107	80+	36 000	24	>0.9	<20
25	23	120	2 305	100	2 396	104	2 472	107	2 487	108	80+	36 000	24	>0.9	<20
34	34	120	3 284	97	3 414	100	3 523	104	3 543	104	80+	36 000	24	>0.9	<20
50	51	120	4 895	96	5 088	100	5 251	103	5 281	104	80+	36 000	24	>0.9	<20

**LINK TECHNICAL SPECIFICATION TABLE**

Series	CRI	Lumen package	Watts (W)	LINK Watts (W)	Color temperature (K)	Lens finish	Beam angle (°)	LINK Lumen output (lm)
CR6	80+	18	19	11	3 000	Clear lens	Narrow	828.78
		25	23					789.39
		34	34					767.96
		50	51					787.62

**COMPATIBLE DIMMERS**

Brand	Model number <sup>1</sup>
Legrand	CD4FBW, WS4FBL3P
Leviton	IP710-DLZ, IP710DLX, CFCS, DS710
Lutron	NOVA NFTV, NOVA T NTSTV, DIVA DVTV, DVSCVT
WATTSTOPPER	ADF-120277

**Dimming range: 1 %-100 %**

<sup>1</sup> 0-10 V dimmers.

NOTE: The above table shows dimmers that have been tested and have demonstrated proper operation under normal conditions. Each installation being unique, various factors such as load, common neutrals or other electrical products on the circuit can, in certain instances, cause variance in system performance. Read and comply to the dimmer installation instructions. Consult dimming system manufacturer for additional support in operation. Stanpro recommends to use dimmers designed to work with LED products. Older dimmers designed for incandescent products may cause erratic operation. Some dimmers may require more than one product for stable operation. The maximum number of products is determined by the dimmer wattage rating with LEDs. Be careful, these dimmers have different ratings depending on the product type. Again, refer to the dimmer installation instructions.

Data is based upon tests performed in a controlled environment. Actual performance can vary depending on operating conditions. All products are subject to change or may be discontinued any time without notice.

**DIMENSIONS**

**CR6  
NON-IC FRAME-IN KIT**

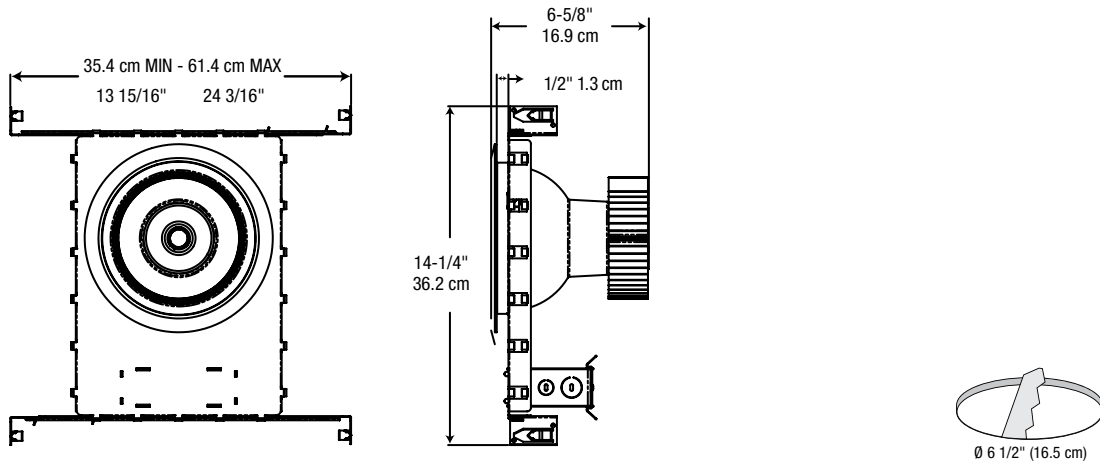

**CR6R  
REMODELER**

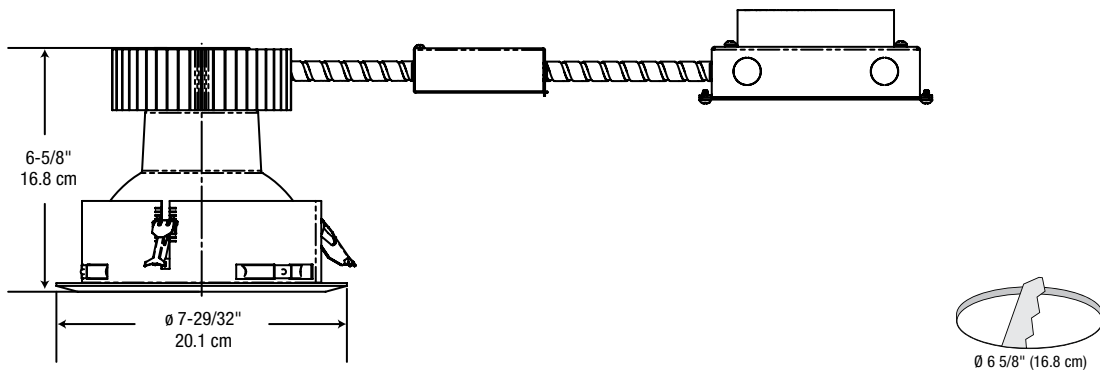

Data is based upon tests performed in a controlled environment. Actual performance can vary depending on operating conditions. All products are subject to change or may be discontinued any time without notice.

# LINK

## NORMALLY ON EMERGENCY REMOTE LUMINAIRE

This luminaire can be used with an emergency backup powered by either a 12 V or 24 V DC Stanpro battery unit, complete with or without auto test.

### NORMAL MODE



### EMERGENCY MODE

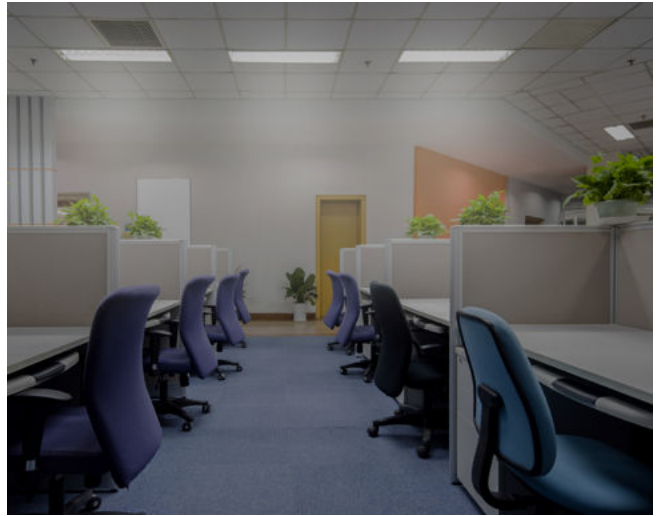

### TYPICAL SPECIFICATION

Supply and install Stanpro LINK \_\_\_\_\_ in, Commercial LED Downlight, Model number: \_\_\_\_\_ remote normally ON emergency luminaire, CSA C22.2 141-15 certified and meet the requirements prescribed by ICES-005. Normally ON when AC is present and when connected to a Stanpro battery unit complete with or without auto test, the luminaire shall act as an emergency lighting remote and consume 11 W of DC power in \_\_\_\_\_ V producing 1 097 - 1 146 lumens in emergency mode.

The remote normally ON emergency luminaire shall be powered by a Stanpro emergency lighting battery unit as described herein and shown on the drawings. The Stanpro auto diagnostic micro-controller board shall supply the rated load for a minimum of a 1/2 hour to 87.5% of the rated battery voltage. The unit shall be rated 120 V, 277 V or 347 V, 60 Hz and be CSA listed. The unit shall have an output of: \_\_\_V and \_\_\_W. The charge voltage factory set to  $\pm 1\%$  tolerance. High Efficacy, rapid recovery, precision control charging system shall be employed to promote long battery life and reduce the potential for grid corrosion. The charger shall provide a continuous high charge to recharge the battery, when the battery is at full capacity, the charger will shut-off. Periodically the charger shall provide a pulse of energy to keep the battery topped off. The pulse charger shall be precisely regulated and shall charge the battery in relation to its temperature, state of charge and input voltage fluctuations. The charger shall be current limited, temperature compensated, short-circuit proof and reverse polarity protected. The unit shall be furnished with an electronic lockout circuit, which will connect the battery when the AC circuit is activated, and an electronic brownout circuit, which will activate the emergency lights when utility power dips below 75% of nominal voltage. A low voltage battery protection circuit shall be provided and will disconnect the load when the battery reaches the end of discharge.

The automated testing performed by the Stanpro auto test system has been designed to comply with all of the requirements of the National Fire Code. Every month, a 5 minute discharge and diagnostic test checks the operational status of the unit. Every 12 months, this test is extended to the full 30 minute, code required duration. This ensures that the battery charger is recharging the battery in accordance with code requirements.

The unit shall be Stanpro model: SL\_ \_\_\_\_\_

Data is based upon tests performed in a controlled environment. Actual performance can vary depending on operating conditions.  
All products are subject to change or may be discontinued any time without notice.

# LINK

## NORMALLY ON EMERGENCY REMOTE LUMINAIRE

### LINK Wiring Diagram

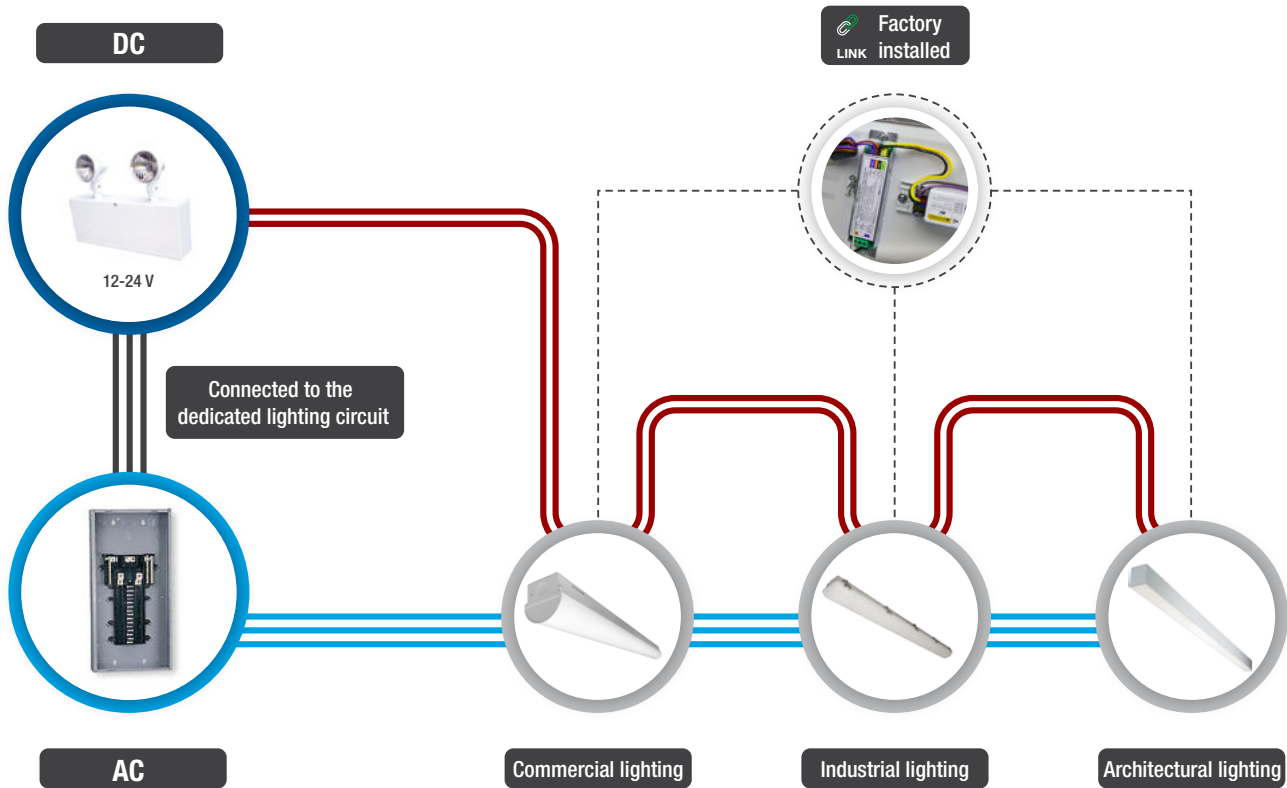

**LEGEND**

- AC wires
- Connected to the dedicated lighting circuit
- DC wires
- LINK factory installed

Emergency mode	Spacing
CR6	Average spacing for 1 out of every 3 luminaires, normally ON in the path of egress, when at 8, 10, or 12 foot mounting heights.

Data is based upon tests performed in a controlled environment. Actual performance can vary depending on operating conditions. All products are subject to change or may be discontinued any time without notice.

**GENERAL LIGHTING PHOTOMETRIC DATA<sup>1</sup>**

**CR6-1880-C0W-30K-N • 1 964.2 lm**

**Polar candela distribution**

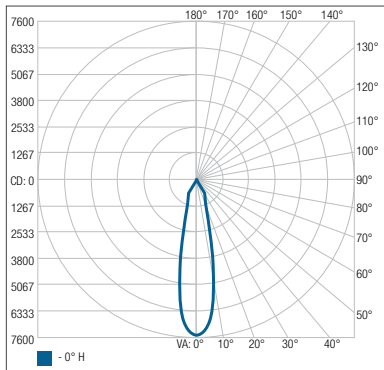

**Zonal lumen summary**

Zone	Lumens	% Fixture
0-30	1 694.2	86.3%
0-40	1 911.0	97.3%
0-60	1 946.3	99.1%
60-90	17.9	0.9%
70-100	10.7	0.5%
90-120	0	0%
0-90	1 964.2	100%
90-180	0	0%
0-180	1 964.2	100%

**Illuminance at a distance**

Center beam fc	Beam width
1.7'	2 596 fc
3.3'	689 fc
5.0'	300 fc
6.7'	167 fc
8.3'	109 fc
10.0'	75.0 fc

■ Beam spread: 24.1°

**CR6-2580-C0W-30K-N • 2 395.8 lm**

**Polar candela distribution**

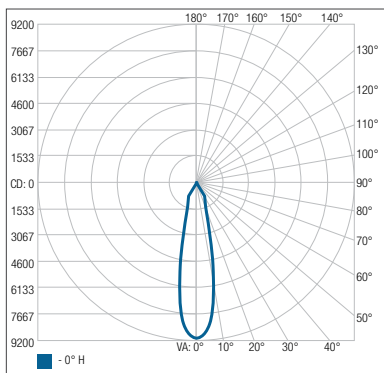

**Zonal lumen summary**

Zone	Lumens	% Fixture
0-30	2 067.5	86.3%
0-40	2 332.1	97.3%
0-60	2 374.9	99.1%
60-90	20.9	0.9%
70-100	12.4	0.5%
90-120	0	0%
0-90	2 395.8	100%
90-180	0	0%
0-180	2 395.8	100%

**Illuminance at a distance**

Center beam fc	Beam width
1.7'	3 168 fc
3.3'	841 fc
5.0'	366 fc
6.7'	204 fc
8.3'	133 fc
10.0'	91.5 fc

■ Beam spread: 24.1°

**CR6-3480-C0W-30K-N • 3 413.6 lm**

**Polar candela distribution**

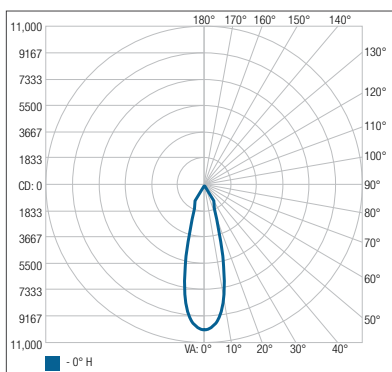

**Zonal lumen summary**

Zone	Lumens	% Fixture
0-30	2 931.8	85.9%
0-40	3 345.8	98%
0-60	3 402.2	99.7%
60-90	11.4	0.3%
70-100	1.2	0%
90-120	0	0%
0-90	3 413.6	100%
90-180	0	0%
0-180	3 413.6	100%

**Illuminance at a distance**

Center beam fc	Beam width
1.7'	3 475 fc
3.3'	922 fc
5.0'	402 fc
6.7'	224 fc
8.3'	146 fc
10.0'	100 fc

■ Beam spread: 29.2°

<sup>1</sup> Complete IES files available on our website.

Data is based upon tests performed in a controlled environment. Actual performance can vary depending on operating conditions. All products are subject to change or may be discontinued any time without notice.

**GENERAL LIGHTING PHOTOMETRIC DATA<sup>1</sup>**

**CR6-5080-C0W-30K-N • 5 088.0 lm**

**Polar candela distribution**

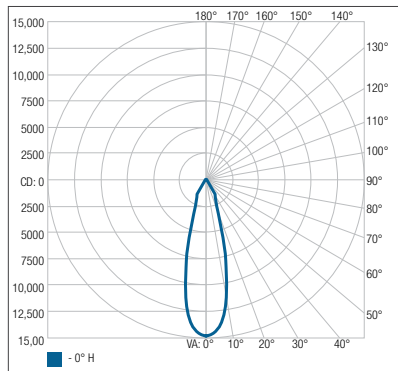

**Zonal lumen summary**

Zone	Lumens	% Fixture
0-30	4 369.9	85.9%
0-40	4 987.0	98%
0-60	5 071.1	99.7%
60-90	16.9	0.3%
70-100	1.8	0%
90-120	0	0%
0-90	5 088.0	100%
90-180	0	0%
0-180	5 088.0	100%

**Illuminance at a distance**

	Center beam fc	Beam width
1.7'	5 179 fc	0.9'
3.3'	1 374 fc	1.7'
5.0'	599 fc	2.6'
6.7'	333 fc	3.5'
8.3'	217 fc	4.3'
10.0'	150 fc	5.2'

■ Beam spread: 29.2°

<sup>1</sup> Complete IES files available on our website.

Data is based upon tests performed in a controlled environment. Actual performance can vary depending on operating conditions. All products are subject to change or may be discontinued any time without notice.