

## Series Spec Sheet

# GIMBAL LED DOWNLIGHT

## Small aperture directional 3" and 4" downlight

The LED Gimbal downlight combines a sleek and versatile design with easy installation. Depending on your needs, you can choose the all-in-one kit or an LED module and a trim of your choice. It is possible to create up to 42 different module-trim combinations! It is available in different color temperature, 3 000, 4 000 and warm-dim 3 000-2 200 K. This downlight is the perfect solution for both new construction and renovation applications.

### FEATURES AND SPECIFICATIONS

#### • Construction

##### Physical Characteristics

- Trim finish white, brushed nickel and black
- Module finish white and brushed nickel
- Round and square trim options
- Available in all-in-one kit white 3" and 4" round
- 24° tilt and 360° module rotation to light any direction
- Polycarbonate clear lens
- FT4 cable rating

##### Mounting

- Twist and lock trim and module installation
- Torsion spring mounting clips
- LED module with LED driver easily installs with included quick connect wire
- Cutting hole Ø 2 ¾" - 4 ¼" (7.0 - 10.8 cm)

#### • Performance data

- Available in 3 000-2 200, 3 000 and 4 000 K
- 80+ and 90+ CRI
- 120 V
- Estimated life of over 36 000 hours to L70
- Phase cut (ELV / Triac) dimming standard
- Operating temperature:
  - 20 °C to 45 °C (-4 °F to 113 °F)

#### • Compliances

- cETLus for damp locations
- Energy Star
- Meets requirements of ICES-005 issue 5 class B for use in residential applications
- IC rated for direct contact with insulation
- Airtight as per ASTM E283 standard



### OVERVIEW

Light source	LED
Watts (W)	7
Lumen output (lm)	473 - 701
Efficiency (lm/W)	68 - 100
Color temperature (K)	3 000-2 200, 3 000, 4 000
CRI	80, 90



quick  
ship



LED  
fixture



airtight



dimmmable



warm<sup>1</sup>  
dim



damp  
location



IC  
rated



ICES  
005



<sup>1</sup> Only for 65981 and 65982.

**QUICK SHIP AND TECHNICAL SPECIFICATION TABLE ALL-IN-ONE KIT ☺<sup>1</sup>**

Order code	Part number	Watts (W)	Volts (VAC)	Color temp. (K) <sup>2</sup>	Lumen output (lm) <sup>3</sup>	Efficacy (lm/W)	CRI	Life L70 (hrs) <sup>4</sup>	Beam angle (°)	Trim type	Cable rating	Finish	Power factor	THD (%)	Traditional equivalent (W)	Case qty (master)
<b>3" Round</b>																
69018	DL/GIMBAL/3IN/RND/7W/30K/WH	7	120	3 000	600	86	80+	36 000	40	Flat	FT4	White	>0.9	<40	50	24
<b>4" Round</b>																
69019	DL/GIMBAL/4IN/RND/7W/30K/WH	7	120	3 000	600	86	80+	36 000	40	Flat	FT4	White	>0.9	<40	50	24

<sup>1</sup> **QUICK SHIP:** Product availability is subject to change without notice. Please contact your Stanpro customer service representative to confirm inventory levels at time of order.

<sup>2</sup> Typical color temperature range: +/- 5 %.

<sup>3</sup> Lumen values are derived from Energy Star reported data. Initial lumens range: +/- 10 %.

<sup>4</sup> Life hours are derived from IESNA LM-80-08 testing report and projected per IESNA TM-21-11 extrapolations.

**QUICK SHIP AND TECHNICAL SPECIFICATION TABLE LED MODULE ☺<sup>1</sup>**

Order code	Part number	Watts (W)	Volts (VAC)	Color temp. (K) <sup>2</sup>	Lumen output (lm) <sup>3</sup>	Efficacy (lm/W)	CRI	Life L70 (hrs) <sup>4</sup>	Beam angle (°)	Cable rating	Finish	Power factor	THD (%)	Traditional equivalent (W)	Case qty (master)	
<b>Warm Dim Modules</b>																
65981	LED/DL/GIMBAL/MOD/7W/30-22K/WH/STD	7	120	3 000-2 200	470	67	90+	30 000	40	FT4	White	>0.9	<40	50	18	
65982	LED/DL/GIMBAL/MOD/7W/30-22K/BN/STD	7	120	3 000-2 200	470	67	90+	30 000	40	FT4	Brushed Nickel	>0.9	<40	50	18	
<b>Modules</b>																
65420	LED/DL/GIMBAL/MOD/7W/30K/WH/STD	7	120	3 000	600	86	80+	36 000	40	FT4	White	>0.9	<40	50	18	
65422	LED/DL/GIMBAL/MOD/7W/30K/BN/STD	7	120	3 000	600	86	80+	36 000	40	FT4	Brushed Nickel	>0.9	<40	50	18	
65421	LED/DL/GIMBAL/MOD/7W/40K/WH/STD	7	120	4 000	620	89	80+	36 000	40	FT4	White	>0.9	<40	50	18	
65423	LED/DL/GIMBAL/MOD/7W/40K/BN/STD	7	120	4 000	620	89	80+	36 000	40	FT4	Brushed Nickel	>0.9	<40	50	18	

<sup>1</sup> **QUICK SHIP:** Product availability is subject to change without notice. Please contact your Stanpro customer service representative to confirm inventory levels at time of order.

<sup>2</sup> Typical color temperature range: +/- 5 %.

<sup>3</sup> Lumen values are derived from Energy Star reported data. Initial lumens range: +/- 10 %.

<sup>4</sup> Life hours are derived from IESNA LM-80-08 testing report and projected per IESNA TM-21-11 extrapolations.

**QUICK SHIP AND TECHNICAL SPECIFICATION TABLE TRIMS ☺<sup>1</sup>**

Order code	Part number	Finish	Type	Case qty (master)
<b>3" Round</b>				
65432	LED/DL/GIMBAL/3IN/TRIM/RND/FLAT/WH/STD	White	Flat	96
65433	LED/DL/GIMBAL/3IN/TRIM/RND/FLAT/BN/STD	Brushed nickel	Flat	96
66230	LED/DL/GIMBAL/3IN/TRIM/RND/FLAT/BK/STD	Black	Flat	96
65450	LED/DL/GIMBAL/3IN/TRIM/RND/CURVED/WH/STD	White	Curved	96
65451	LED/DL/GIMBAL/3IN/TRIM/RND/CURVED/BN/STD	Brushed Nickel	Curved	96
<b>3" Square</b>				
65434	LED/DL/GIMBAL/3IN/TRIM/SQR/FLAT/WH/STD	White	Flat	96
65435	LED/DL/GIMBAL/3IN/TRIM/SQR/FLAT/BN/STD	Brushed Nickel	Flat	96
66231	LED/DL/GIMBAL/3IN/TRIM/SQR/FLAT/BK/STD	Black	Flat	96
<b>4" Round</b>				
65436	LED/DL/GIMBAL/4IN/TRIM/RND/FLAT/WH/STD	White	Flat	96
65437	LED/DL/GIMBAL/4IN/TRIM/RND/FLAT/BN/STD	Brushed Nickel	Flat	96
66232	LED/DL/GIMBAL/4IN/TRIM/RND/FLAT/BK/STD	Black	Flat	96
<b>4" Square</b>				
65438	LED/DL/GIMBAL/4IN/TRIM/SQR/FLAT/WH/STD	White	Flat	96
65439	LED/DL/GIMBAL/4IN/TRIM/SQR/FLAT/BN/STD	Brushed Nickel	Flat	96
66233	LED/DL/GIMBAL/4IN/TRIM/SQR/FLAT/BK/STD	Black	Flat	96

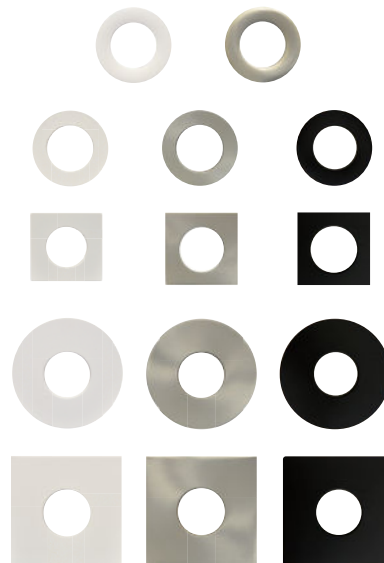

<sup>1</sup> **QUICK SHIP:** Product availability is subject to change without notice. Please contact your Stanpro customer service representative to confirm inventory levels at time of order.

Data is based upon tests performed in a controlled environment. Actual performance can vary depending on operating conditions. All products are subject to change or may be discontinued any time without notice.

**LUMEN SPECIFICATION TABLE**

Order code	Model number	Watts (W)	3 000-2 200 K		3 000 K		4 000 K	
			Lumen output (lm)	Efficacy (lm/W)	Lumen output (lm)	Efficacy (lm/W)	Lumen output (lm)	Efficacy (lm/W)
65981	LED/DL/GIMBAL/MOD/7W/30-22K/WH/STD	7	473.1	68				
65982	LED/DL/GIMBAL/MOD/7W/30-22K/BN/STD	7	473.1	68				
65420	LED/DL/GIMBAL/MOD/7W/30K/WH/STD	7			687.8	98		
65422	LED/DL/GIMBAL/MOD/7W/30K/BN/STD	7			687.8	98		
65421	LED/DL/GIMBAL/MOD/7W/40K/WH/STD	7					701.2	100
65423	LED/DL/GIMBAL/MOD/7W/40K/BN/STD	7					701.2	100
69018	DL/GIMBAL/3IN/RND/7W/30K/WH	7			687.8	98		
69019	DL/GIMBAL/4IN/RND/7W/30K/WH	7			687.8	98		

**ACCESSORIES (order separately)**

Order code	Model number	Type	Opening diameter (in)	Case qty (master)
66020	ACC/MPLATE/2.75IN/SQR/STD	Square and mounting plate	2 3/4	94
66021	ACC/MPLATE/2.75IN/ADJ/STD	Adjustable plate	2 3/4	24
66819	ACC/MPLATE/2.75IN/HANG.BARS/STD	Mounting plate with hanger bars	2 3/4	25
64264	LPDL/ACC/6FT/EXT.CABLE/STD	6' extension cord	-	96
66142	ACC/3/VAPOR BARRIER/STD	Vapor barrier extender	3 5/8	50



**COMPATIBLE DIMMERS<sup>1</sup>**

Brand	Module 3 000 and 4 000 K	Module 3 000-2 200 K
	Model	
Cooper	AAL06	AAL06, DAL06P, SLC03P
Leviton	6615, 6674, DSL06-1LZ, IPE04-1LZ, IPL06	6615, 6674, DSL06-1LZ, IPE04-1LZ, IPL06
Lutron	AYCL-253P, CTCL-153P, DVCL-153P, DVCL-253P, DVELV-300P, SELV-300P	AYCL-253P, CTCL-153P, DVCL-153P, DVCL-253P, DVELV-300P, NTELV-600, PD-06WCL, SELV-300P

Dimming range : 10%-100%

<sup>1</sup> This table shows dimmers that have been tested and have demonstrated proper operation under normal conditions. Each installation being unique, various factors such as load, common neutrals or other electrical products on the circuit can, in certain instances, cause variance in system performance. Read and comply to the dimmer installation instructions. Consult dimming system manufacturer for additional support in operation. Some dimmers may require more than one product for stable operation. Stanpro recommends to use dimmers designed to work with LED products. Older dimmers designed for incandescent products may cause erratic operation.

Data is based upon tests performed in a controlled environment. Actual performance can vary depending on operating conditions. All products are subject to change or may be discontinued any time without notice.

**DIMENSIONS AND WEIGHTS**

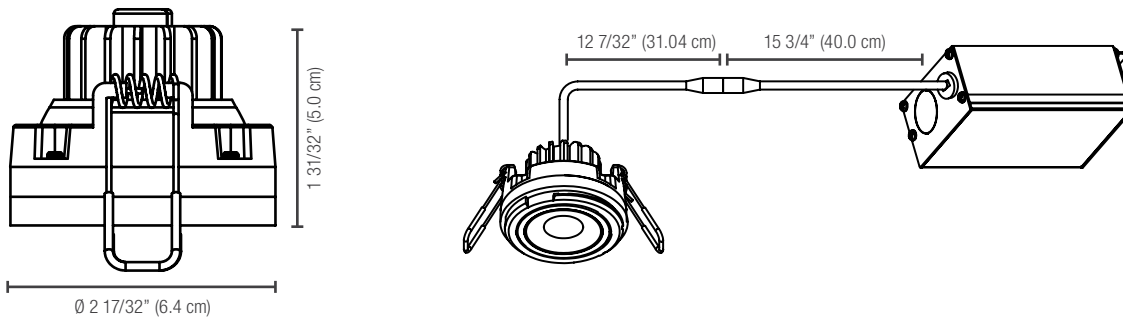

**3" Trim**

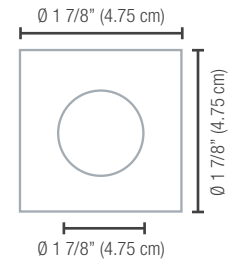
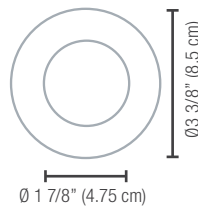

**4" Trim**

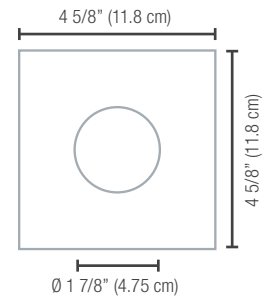
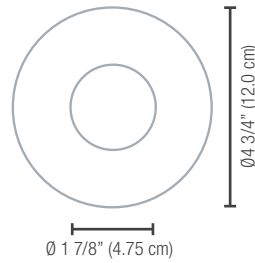

	3" Round kit	4" Round kit	LED Module	3" Trim	4" Trim
Net weight (lbs)	1.1	1.19	0.8	0.09	0.13

Data is based upon tests performed in a controlled environment. Actual performance can vary depending on operating conditions. All products are subject to change or may be discontinued any time without notice.

**PHOTOMETRIC DATA<sup>1</sup>**

**65981 • LED/DL/GIMBAL/MOD/7W/30-22K/WH/STD • 473.1 lm**

**Polar candela distribution**

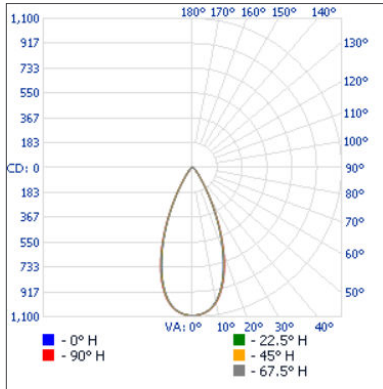

**Zonal lumen summary**

Zone	Lumens	% Fixture
0-30	371.8	78.6
0-40	423.9	89.6
0-60	459.7	97.2
60-90	12.9	2.7
70-100	4.8	1
90-120	0.1	0
0-90	472.6	99.9
90-180	0.5	0.1
0-180	473.1	100

**Illuminance at a distance**

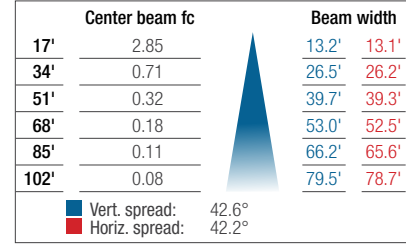

**65420 • LED/DL/GIMBAL/MOD/7W/30K/WH/STD • 687.8 lm**

**Polar candela distribution**

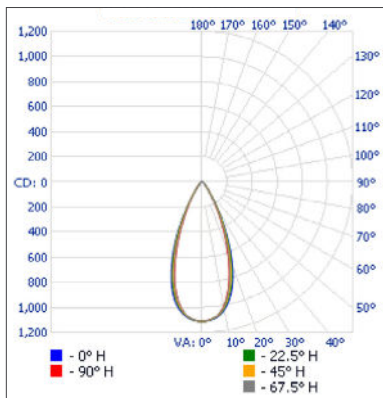

**Zonal lumen summary**

Zone	Lumens	% Fixture
0-30	529.9	77
0-40	610.4	88.7
0-60	665.5	96.8
60-90	21.2	3.1
70-100	7.9	1.2
90-120	0	0
0-90	686.8	99.8
90-180	1.1	0.2
0-180	687.8	100

**Illuminance at a distance**

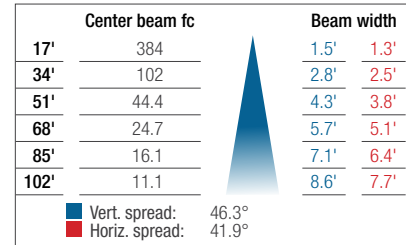

**69018 • DL/GIMBAL/3IN/RND/7W/30K/WH • 687.8 lm**

**Polar candela distribution**

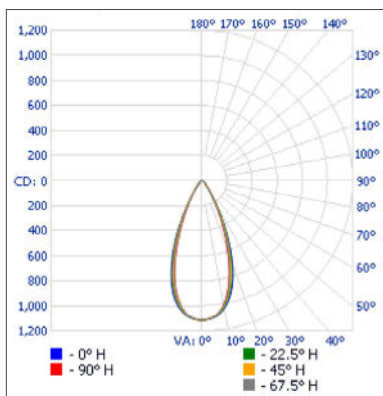

**Zonal lumen summary**

Zone	Lumens	% Fixture
0-30	529.9	77
0-40	610.4	88.7
0-60	665.5	96.8
60-90	21.2	3.1
70-100	7.9	1.2
90-120	0	0
0-90	686.8	99.8
90-180	1.1	0.2
0-180	687.8	100

**Illuminance at a distance**

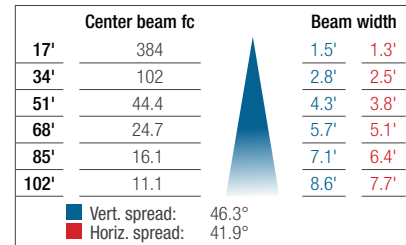

<sup>1</sup> Complete IES files available on our website.

Data is based upon tests performed in a controlled environment. Actual performance can vary depending on operating conditions. All products are subject to change or may be discontinued any time without notice.