



Series Spec Sheet

MULTI-CELLS DOT SERIES - L3DOT

MINIATURIZED LINEAR RECESSED LIGHTING FOR A SEAMLESS EFFECT!

L3DOT series is the perfect aesthetic choice. Its unique style provides a touch of elegance to any project. This linear luminaire delivers a high quality light and offers the freedom to mix and match finishes, enlarging design options for both accent and general lighting applications. This slim recessed luminaire also offers two beam spreads to ensure desired result is achieved.

FEATURES AND SPECIFICATIONS

• Construction

Housing

The body is made of die-cast aluminium

Finishes

Inner baffle: Matt white, matt black, matt silver, matt gold

Flange: White, black

Inner baffle made of strong and resistant polycarbonate material

Optique

Individual optical component for each cell for better control of light and a better definition of beam diffusion.

• Installation

Recessed mount with simple torsion spring clips. Remote junction box and driver with easy quick connectors to the LED engine.

Type non-IC, suitable for use in non-insulated ceilings. Refer to the installation instructions for more details.

• Specifications

Quality LED light with high color rendering of 90. LED chip binning 3 step MacAdam Ellipse to ensure color consistency.

Dimming

2 cells and 3 cells configurations are not dimmable and available in 120-277 V only.

5 cells configuration is available with phase-cut line voltage dimming when choosing 120 V or 0-10 V dimming when choosing 120-277 V option.

10 cells configuration is available with phase-cut line voltage dimming and with 0-10 V dimming when choosing 120 V option.

Lumens

160-170 lm/cell

Beam angle

- Narrow flood (24°)
- Flood (40°)

Ambient temperature

-20°C to 35°C

• Compliances

- cETLus
- ICES-005 for Class B products
- Suitable for dry locations



canadian assembled



LED fixture



dimmable



dry location



ICES 005



Intertek

OVERVIEW

| | |
|-----------------------|---------------------|
| Light source | LED |
| Watts (W) | 4 - 22 |
| Lumen output (lm) | 300 - 1 700 |
| Efficacy (lm/W) | 61 - 90 |
| Color temperature (K) | 3 000, 3 500, 4 000 |
| CRI | 90 |
| Weight (lbs) | 2 cells: 1.43 |
| | 3 cells: 1.47 |
| | 5 cells: 1.63 |
| | 10 cells: 2.07 |

ORDERING GUIDE

| L3DOT | | F | L | S1 | 90 | | | | | |
|--------|--|-----------|-----------|-------------------------|----------|--|--|------------------------|---|---|
| Series | Configuration | Type | Lamp type | Lumen package (lm/cell) | CRI | Volts (V) | Inner baffle finish | Flange finish | Color temp. (K) | Beam angle (°) |
| L3DOT | 2 - 2 cells 3 - 3 cells 5 - 5 cells 10 - 10 cells | F - Fixed | L - LED | S1 - 160-170 | 90 - 90+ | A - 120 ¹ W - 120-277 ² | W - White B - Black S - Silver G - Gold | W - White B - Black | 30K - 3 000 35K - 3 500 40K - 4 000 | N - Narrow Flood (24) F - Flood (40) |

¹ For 5 cells configuration phase-cut dimming with 120 V.
¹ For 10 cells configuration available with phase-cut and 0-10 V dimming with 120 V.
² For 2 and 3 cells configurations non-dimmable 120-277 V only.
² For 5 cells configuration 0-10 V dimming with 120-277 V.

QUICK SHIP AND TECHNICAL SPECIFICATION TABLE

| Order code | Model number | Watts (W) | Volts (V AC) | Color temp. (K) ¹ | Lumen output (lm) ² | Efficacy (lm/W) | CRI | Tested hours LM-80 (hrs) ³ | Beam angle (°) | Finish | Dimming (Yes/No) |
|-----------------|----------------------------|-----------|----------------------|------------------------------|--------------------------------|-----------------|-----|---------------------------------------|----------------|--------|------------------|
| 2 Cells | | | | | | | | | | | |
| 69350 | L3DOT-2F-LS190-WBB/30K-F | 4 | 120-277 ⁴ | 3 000 | 160-170 | 40-42 | 90+ | 50 000 | 40 | Black | No |
| 69351 | L3DOT-2F-LS190-WWW/30K-F | 4 | 120-277 ⁴ | 3 000 | 160-170 | 40-42 | 90+ | 50 000 | 40 | White | No |
| 3 Cells | | | | | | | | | | | |
| 69352 | L3DOT-3F-LS190-WBB/30K-F | 7 | 120-277 ⁴ | 3 000 | 160-170 | 40-42 | 90+ | 50 000 | 40 | Black | No |
| 69353 | L3DOT-3F-LS190-WWW/30K-F | 7 | 120-277 ⁴ | 3 000 | 160-170 | 40-42 | 90+ | 50 000 | 40 | White | No |
| 5 cells | | | | | | | | | | | |
| 69354 | L3DOT-5F-LS190-ABB/30K-F | 13 | 120 ⁵ | 3 000 | 160-170 | 40-42 | 90+ | 50 000 | 40 | Black | Yes |
| 69355 | L3DOT-5F-LS190-WBB/30K-F | 13 | 120-277 ⁶ | 3 000 | 160-170 | 40-42 | 90+ | 50 000 | 40 | Black | Yes |
| 69356 | L3DOT-5F-LS190-AWW/30K-F | 13 | 120 ⁵ | 3 000 | 160-170 | 40-42 | 90+ | 50 000 | 40 | White | Yes |
| 69357 | L3DOT-5F-LS190-WWW/30K-F | 13 | 120-277 ⁶ | 3 000 | 160-170 | 40-42 | 90+ | 50 000 | 40 | White | Yes |
| 10 cells | | | | | | | | | | | |
| 69358 | L3DOT -10F-LS190-ABB/30K-F | 22 | 120 ⁷ | 3 000 | 160-170 | 40-42 | 90+ | 50 000 | 40 | Black | Yes |
| 69359 | L3DOT-10F-LS190-AWW/30K-F | 22 | 120 ⁷ | 3 000 | 160-170 | 40-42 | 90+ | 50 000 | 40 | White | Yes |

¹ Typical color temperature range: +/- 5 %.
² Lumen values are derived from photometric testing. Initial lumens range: +/- 10 %.
³ Life hours are derived from IESNA LM-80-08 testing report and projected per IESNA TM-21-11 extrapolations.
⁴ For 2 and 3 cells configurations non-dimmable 120-277 V only.
⁵ For 5 cells configuration phase-cut dimming with 120 V.
⁶ For 5 cells configuration 0-10 V dimming with 120-277 V.
⁷ For 10 cells configuration available with phase-cut and 0-10 V dimming with 120 V.

Consult factory for lead time .

FINISHES AVAILABLE

Inner Baffle Finish



Black White Silver Gold

Flange Finish



White Black

BEAM ANGLES

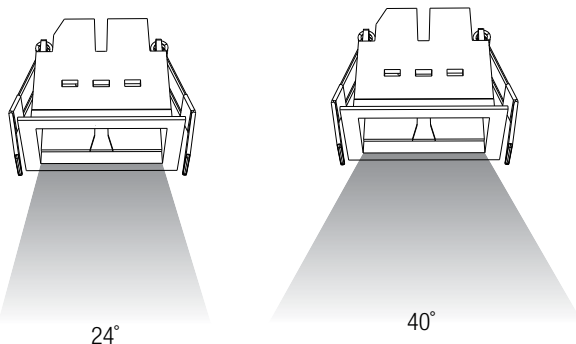

24°

40°

Data is based upon tests performed in a controlled environment. Actual performance can vary depending on operating conditions. All products are subject to change or may be discontinued any time without notice.

COMPATIBLE DIMMERS¹

| | 5 CELLS & 10 CELLS Phase-cut line voltage dimming | 5 CELLS & 10 CELLS 0-10 V dimming |
|---------|--|--------------------------------------|
| Brand | Model | |
| Lutron | PD-5NE, PD-6WCL, RRD-6NA, DVCL-153P, CTCL-153P, DVCL-253P, AYCL-253P, DVRP-253, SELV-300P, MACL-153P | DIVA DVSTV, NOVA NTSTV DV |
| Cooper | AAL06, SAL06P3 | - |
| Leviton | 066EV, IPL06, 6674, DSL06-1ZL, DSM10-1LZ, IPE04-1LZ, DDMX1 | DD 710, AWSMT-7DW, DS 710 |
| Legrand | | RH4FBL3PTC, WS4FBL3P |

Dimming range: 10%-100%

¹ This table shows dimmers that have been tested and have demonstrated proper operation under normal conditions. Each installation being unique, various factors such as load, common neutrals or other electrical products on the circuit can, in certain instances, cause variance in system performance. Read and comply to the dimmer installation instructions. Consult dimming system manufacturer for additional support in operation. Some dimmers may require more than one product for stable operation. Stanpro recommends to use dimmers designed to work with LED products. Older dimmers designed for incandescent products may cause erratic operation.

DIMENSIONS

LUMINAIRE

2 cells

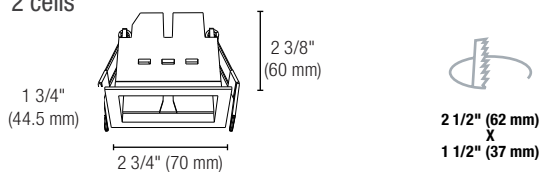

5 cells

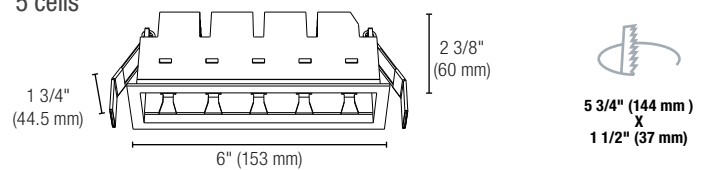

3 cells

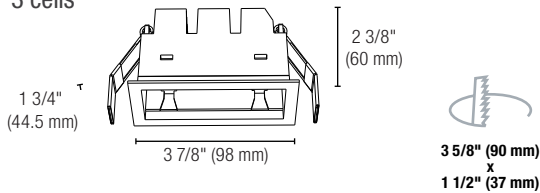

10 cells

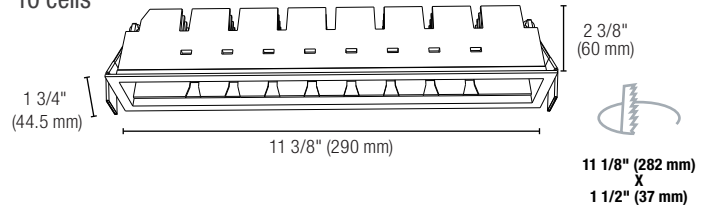

MAKE CEILING CUTOUT

Only fit for the ceiling of thickness between 1 mm to 25 mm

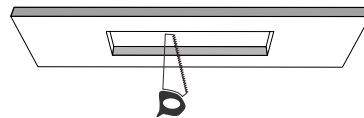

LED DRIVER JUNCTION BOX

2 cells and 3 cells

5 cells and 10 cells

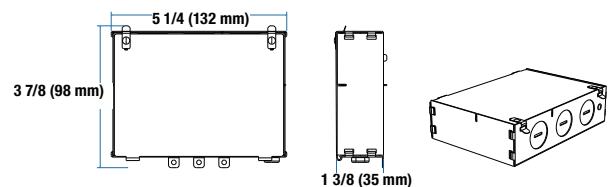
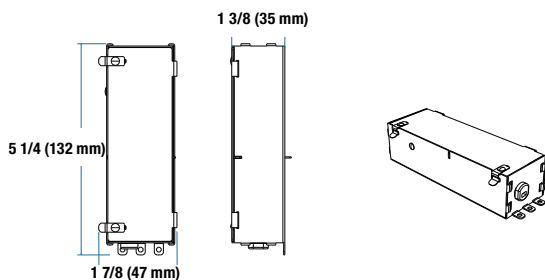

Data is based upon tests performed in a controlled environment. Actual performance can vary depending on operating conditions. All products are subject to change or may be discontinued any time without notice.

PHOTOMETRIC DATA¹

L3DOT-2FLS190-XX-XX-40K-F • 337.2 lm

Polar candela distribution

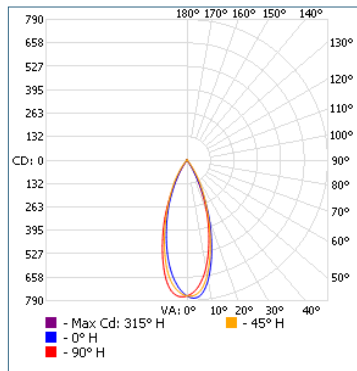

Zonal lumen summary

| Zone | Lumens | % Fixture |
|-------|--------|-----------|
| 0-30 | 304.3 | 90.2 |
| 0-40 | 334.8 | 99.3 |
| 0-60 | 337.2 | 100 |
| 60-90 | 0.1 | 0 |
| 0-90 | 337.2 | 100 |

Illuminance at a distance

| Center beam fc | Beam width | |
|----------------|------------|-----------|
| | 1.3' | 1.4' |
| 2.0' | 190.7 | 1.3' 1.4' |
| 4.0' | 47.7 | 2.7' 2.7' |
| 6.0' | 21.2 | 4.0' 4.1' |
| 8.0' | 11.9 | 5.3' 5.4' |
| 10.0' | 7.6 | 6.6' 6.8' |

■ Vert. spread: 36.7°
■ Horiz. spread: 37.5°

L3DOT-3FLS190-XX-XX-40K-F • 507.9 lm

Polar candela distribution

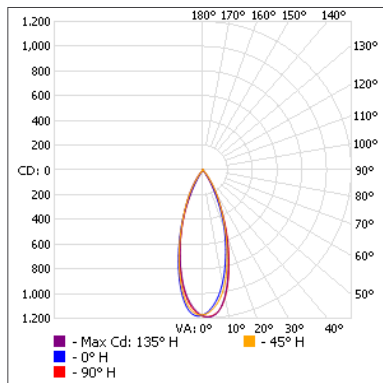

Zonal lumen summary

| Zone | Lumens | % Fixture |
|-------|--------|-----------|
| 0-30 | 458.8 | 90.3 |
| 0-40 | 504.3 | 99.3 |
| 0-60 | 507.8 | 100 |
| 60-90 | 0.1 | 0 |
| 0-90 | 507.9 | 100 |

Illuminance at a distance

| Center beam fc | Beam width | |
|----------------|------------|-----------|
| | 1.3' | 1.4' |
| 2.0' | 293.1 | 1.3' 1.4' |
| 4.0' | 73.3 | 2.6' 2.7' |
| 6.0' | 32.6 | 3.9' 4.1' |
| 8.0' | 18.3 | 5.2' 5.4' |
| 10.0' | 11.7 | 6.6' 6.8' |

■ Vert. spread: 36.3°
■ Horiz. spread: 37.3°

L3DOT-5FLS190-XX-XX-40K-F • 844.2 lm

Polar candela distribution

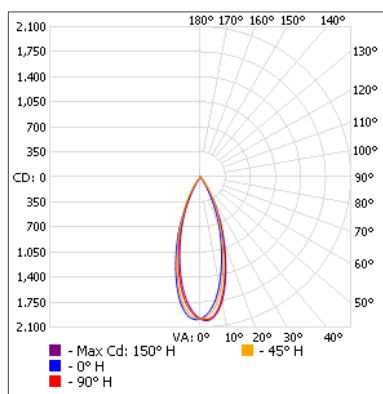

Zonal lumen summary

| Zone | Lumens | % Fixture |
|-------|--------|-----------|
| 0-30 | 763.3 | 90.4 |
| 0-40 | 838.2 | 99.3 |
| 0-60 | 844.0 | 100 |
| 60-90 | 0.2 | 0 |
| 0-90 | 844.2 | 100 |

Illuminance at a distance

| Center beam fc | Beam width | |
|----------------|------------|-----------|
| | 1.3' | 1.3' |
| 2.0' | 495.6 | 1.3' 1.3' |
| 4.0' | 123.9 | 2.6' 2.6' |
| 6.0' | 55.1 | 3.9' 4.0' |
| 8.0' | 31. | 5.2' 5.3' |
| 10.0' | 19.8 | 6.5' 6.6' |

■ Vert. spread: 36.1°
■ Horiz. spread: 36.6°

¹ Complete IES files available on our website.

Data is based upon tests performed in a controlled environment. Actual performance can vary depending on operating conditions. All products are subject to change or may be discontinued any time without notice.

PHOTOMETRIC DATA¹

L3DOT-10FLS190-XX-XX-40K-F • 1 699.2 lm

Polar candela distribution

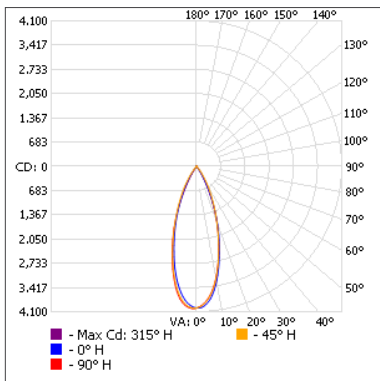

Zonal lumen summary

| Zone | Lumens | % Fixture |
|-------|---------|-----------|
| 0-30 | 1 532.9 | 90.2 |
| 0-40 | 1 684.0 | 99.1 |
| 0-60 | 1 696.8 | 99.9 |
| 60-90 | 2.4 | 0.1 |
| 0-90 | 1 699.2 | 100 |

Illuminance at a distance

| | Center beam fc | Beam width | |
|-------|----------------|------------|------|
| 2.0' | 997.9 | 1.3' | 1.3' |
| 4.0' | 249.5 | 2.6' | 2.7' |
| 6.0' | 110.9 | 3.9' | 4.0' |
| 8.0' | 62.4 | 5.2' | 5.3' |
| 10.0' | 39.9 | 6.5' | 6.6' |

■ Vert. spread: 36.2°
■ Horiz. spread: 36.8°

¹ Complete IES files available on our website.

Data is based upon tests performed in a controlled environment. Actual performance can vary depending on operating conditions. All products are subject to change or may be discontinued any time without notice.